

SWL90-ANP

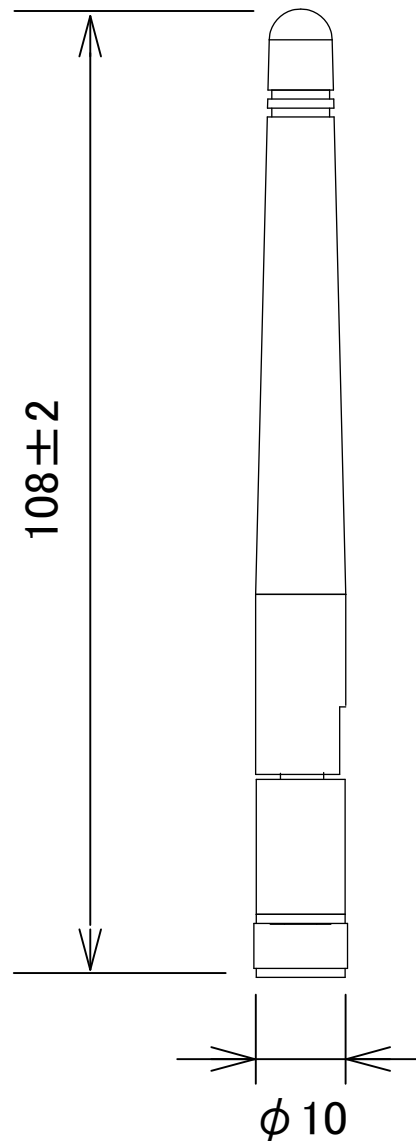
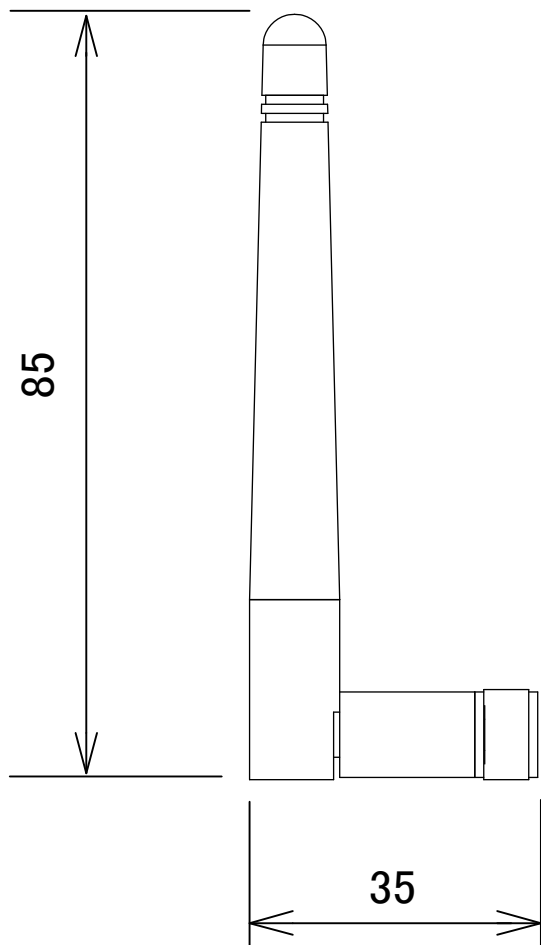

[mm]